

STYLE K GUTTER - SEAMLESS

5" K GUTTER

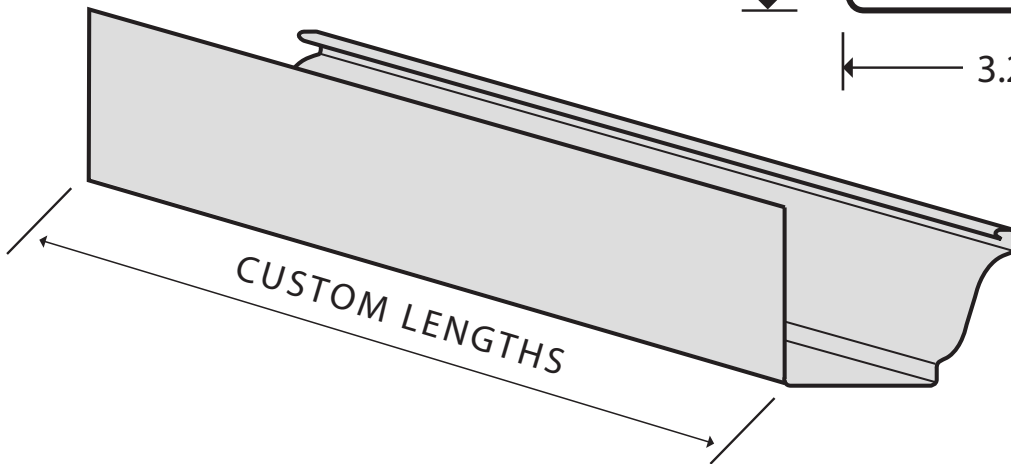
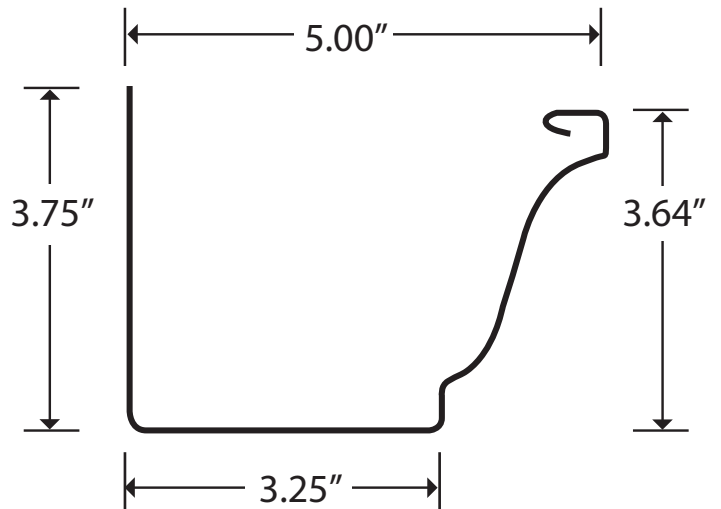

Color: _____

Approved by: _____ Date: _____

METAL	<input type="checkbox"/> .032 Aluminium	<input type="checkbox"/> 24 Gauge Steel
	<input type="checkbox"/> .040 Aluminium	<input type="checkbox"/> 20 Oz. Copper
		<input type="checkbox"/> 16 Oz. Copper

FINISH	<input type="checkbox"/> Kynar 500
	<input type="checkbox"/> Galvalume
	<input type="checkbox"/> Galvanized
	<input type="checkbox"/> Mill Finish Aluminium
	<input type="checkbox"/> Baked Enamel
	<input type="checkbox"/> _____

JOB INFO	Project	_____
	Architect	_____
	Contractor	_____
	Contact	_____
	Phone	_____
	Email	_____