

8 INCH HIDDEN HANGER

Gusseted for Reinforcement

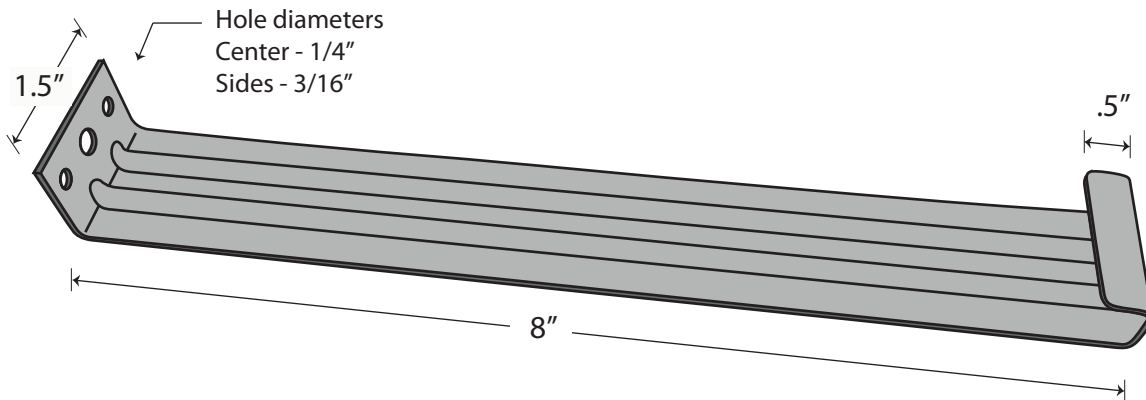

Approved by: _____ Date: _____

METAL

.063 Aluminium

16 Gauge Galvanized Steel

18 Gauge Stainless Steel

JOB INFO

Project _____

Architect _____

Contractor _____

Contact _____

Phone _____

Email _____